

Rain-O-Matic Professional Rain Gauge

Technical specifications

Rain collector/Tipping spoon

RAIN-O-MATIC PROFESSIONAL measures the precipitation by means of a funnel (orifice 200 cm²), which leads the water down into the self-emptying tipping POM bucket, held in place by a hard ferrite magnet. The magnet always exerts just enough tension to allow the measuring bucket to empty in one quick movement (less than 300 ms) and then return to its normal position, ready to once again collect precipitation. This means the counter weight always remains the same opposite to other conventional two spoons tipping bucket rain gauges.

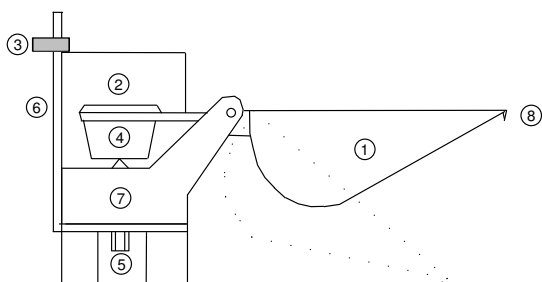

1. Self-emptying bucket
2. PCB with reed switch
3. Screw to hold the entire unit
4. Magnet
5. Adjustment screw
6. Angle brackets
7. Holder for bucket
8. Drip catcher

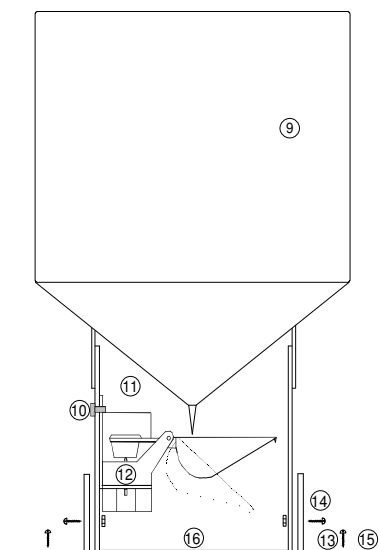

9. Funnel with grille
10. Screw for whole measurement unit
11. Box with measurement unit
12. Measurement unit
13. 4 pcs. screw
14. 4 pcs. screw with nuts
15. 2 pcs. angle brackets
16. Baseplate

Styrosun

The rain gauge is mainly made in moulded modified high-impact polystyrene also known as STYROSUN which is a highly weather-resistant polymer that reduces breakdown and discoloration.

STYROSUN which has passed the Arizona test is extremely resistant against the sun's UV radiation and it is frost- and heat resistant standing all climatically conditions.

STYROSUN is resistant to common household cleaners, recyclable and easily decorated.

PCB

The electronic printed circuit board with individually tested and high quality reed switches is protected against extreme weather conditions such as extreme frost or heat. This include corrosion from salt water due to the PCB is coated with weather-resistant varnish.

The printed circuit board comes in two versions

- Version 1: PCB No. 9601 (NC—normally closed) has male connection and 1 reed switch .

- Version 2: PCB No. 9602 (NC—Normally closed, NO—Normally open) Terminal strip, 4 connections / 2 outlets) and 2 reed switches, connected-up in series by 1 k W 1/4W resistor.

PCB no. 9601 PCB no. 9602

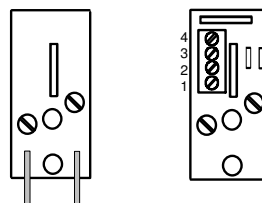

Operating times for PCB no. 9602

| Terminal Strip | Reed Switch | 0,2 mm/tip | 0,25 mm/tip | 0,50 mm/tip |
|----------------|-----------------|---------------|---------------|---------------|
| 1 - 2 | Normally Closed | 190 ms open | 220 ms open | 255 ms open |
| 3 - 4 | Normally Open | 255 ms closed | 225 ms closed | 295 ms closed |

Resolution

- 0,20 mm
- 0,25 mm
- 0,50 mm
- 1/100 inch

Patent

RAIN-O-MATIC PROFESSIONAL is patented and protected by the Law of Copyright. Patent no. UM-27598, AU pat. 565951, EPO Pat. 014212, US pat. 4.644.786, CA Pat. 126181, Japan Pat. 501208/83 Taiwan Reg. 74-201292

Components may NOT be used for other products or purposes without a written approval from PRONAMIC ApS. Violation implies immediate prosecution.

Rain-O-Matic Professional Rain Gauge

Measurements

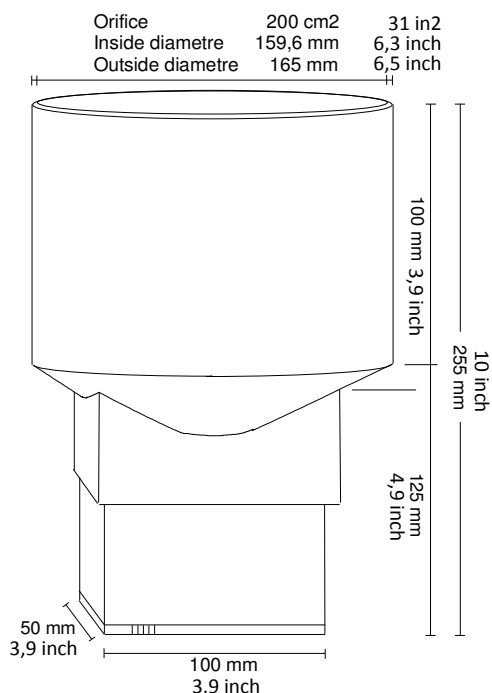

Splash room
height incl.
bottom: 170 mm 6,7 inch

Weight incl.
angle brackets: 380 g 13,5 oz

Capacity per minute with 12 tips

0,20 mm: 2,4 mm
0,25 mm: 3,0 mm
0,50 mm: 6,0 mm
1/100 inch: 0,12 inch

Item list of components

| | |
|-----------------------------------|---------|
| Complete rain measuring unit | 100.005 |
| Rain measuring bucket with magnet | 100.008 |
| Baseplate | 500.016 |
| Funnel with grille | 500.019 |
| Angle brackets | 500.031 |
| Printed circuit board no. 9601 | 100.013 |
| Printed circuit board no. 9602 | 500.510 |

Item list of complete collectors

Rain collector with PCB no. 9601 resolution 0,20 mm JRP-021-20

Rain collector with PCB no. 9601 resolution 0,25 mm JRP-021-25

Rain collector with PCB no. 9601 resolution 0,50 mm JRP-021-50

Rain collector with PCB no. 9602 resolution 0,20 mm JRP-023-20

Rain collector with PCB no. 9602 resolution 0,25 mm 300.023-25

Rain collector with PCB no. 9602 resolution 0,50 mm 300.023-50

Rainfall intensity diagrams

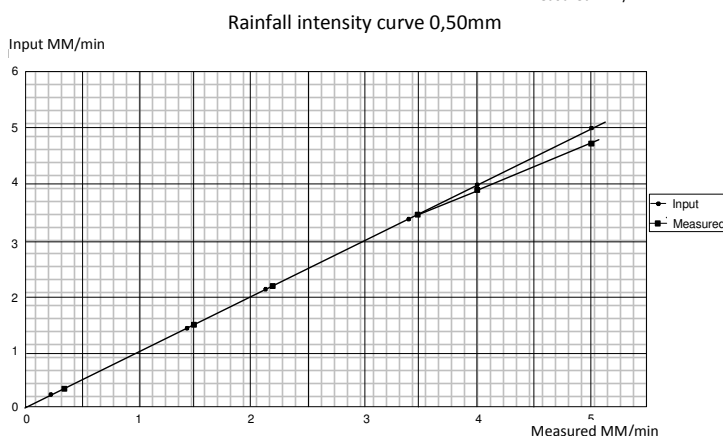
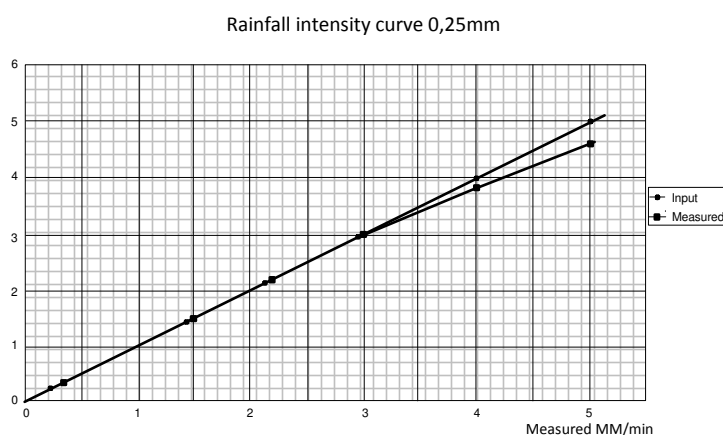
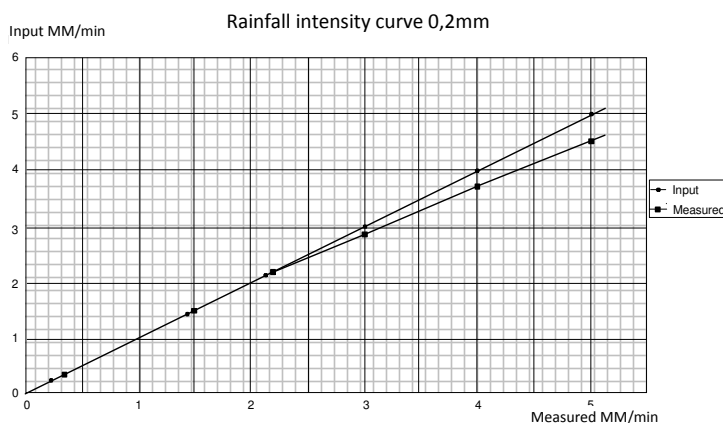

Rain-O-Matic Professional Rain Gauge

Rain-O-Matic Professional rain gauge with our patented self-emptying tipping bucket is one of the most accurate and reliable precipitation gauges on the market and for 28 years we have supplied more than 200.000 rain gauges to 41 countries on 5 continents.



Flexible cable connections

We can manufacture the rain gauges with a variety of connection cables so they will fit into your system. For example:

- Binder connection.
- Jack plug.
- Standard two poles.

Applications areas

The Rain-O-Matic Professional Rain Gauge is light (380 gr) but rugged which makes it perfect for:

- Weather stations (MAWS)
- Water works
- Wastewater treatment plants
- Hydropower stations
- Irrigation
- Agriculture
- Military
- Highway Authorities
- Constructions Engineers
- Forestry

We deliver directly to you. We have no agents, distributors or other expensive middlemen.

Tipping bucket

RAIN-O-MATIC Professional patented self-emptying tipping bucket is one of the most accurate and reliable rain gauges on the market. It gives you advantages in:

- More accurate measurements.
- Only one adjustment screw which makes it easy to recalibrate.
- Bucket made in POM, which is a more dismissive material and therefore makes dust and dirt not stick so easily on the spoon and maximize water release.

Calibration

Calibration is a very important issue for Pronamic and therefore all Professional rain gauges are manually calibrated. It gives you the guarantee for a very accurate measurement.

Minimal maintenance

Our rain gauges require minimal maintenance due to:

- Outer shell is made from Styrosun which makes the surface easy to clean.
- High quality materials and a simple design for a very long durability (10-20 years)

Tests

Rain-O-Matic Professional Rain Gauge has been thoroughly tested by the Danish Ministry of Agriculture, State Field Experiment, Department of Agricultural Meteorology, Research Center Foulum, DK-8830 Tjele

All components are RoHS compliant. Rain-O-Matic Professional has been tested 100 % frost proof.

Warranty

Our rain gauges are of such a high quality that we offer 24 months of warranty on mechanical- and plastic parts. See Service & Support for further information.

Accessories

Currently we can offer following accessories:

- Air Bubble leveling
- Standard 1m binder cable
- Bird protection
- Leaf filter
- Standard pole bracket
- Spider protection