



**DIGITAL
TEMPERATURE
CONTROLLER**

TTM-J4/J5

**Versatile Controller for Wide Range of Applications!
Easy Operation & Economical Price!!**



TTM-J4



TTM-J5

TOHO ELECTRONICS INC.

DIGITAL TEMPERATURE CONTROLLER TTM-J4/J5

Upgraded Digital Temperature Controller with Various Functions, Easy-to-Use & Multiple Inputs

Features

Self-Tuning PID

Most appropriate PID constant is automatically reckoned up for control objects. PID constant is calculated when making alteration of setting value, or it is corrected when occurring disturbance/hunting etc.

Blind Function

At the request, desirable parameter screen is only displayed and set up.

Simplified Timer

ON/OFF setting control is available after some certain interval. Function of ON/OFF alarm output is independently usable.

Priority Display

Demanding parameter screens are monitored and set up under operational mode screen. (max. 9 screens)

Multiple Inputs

Thermocouple/R.T.D.(Pt 100 & JPt 100) are selectable by front key.

Compact Size

It is a compact size. The depth is only 77mm!

Manual Control (Balanceless & Bumpless)

Manual output function is applicable for versatile applications of instrumentation systems.

Digital PV Filter

For abrupt alteration of input value, filter effect is operational on software.

PID Over-Shoot Protection

It is functional to inhibit PID Over-Shoot.

Heating/Cooling Control

PID control is available on cooling side.

Other

Shift setting of OFF position during ON/OFF control, for both output 1 & 2.

Front Panel

TTM-J4 (48 x 48mm)

TTM-J5 (96 x 48mm)

AL1	Output monitor for event output 1
AL2	Output monitor for event output 2
OUT1	Output monitor for output 1
OUT2	Output monitor for output 2
RDY	Lighting while being operation ready
MODE	Mode key for shifting display
FUNC	Function key for digit shift, AT(Auto-Tuning), RUN/READY, Timer Start/Reset
PV	Indication of process value & character display for alarm, PID etc.
SV	Indication of setting value, manipulation value & residual time of timer.
	Up/Down key for alteration of setting value Pressing 1 ~ 10sec: 1 digit/100ms 10 ~ 20sec: 10 digits/100ms over 20sec: 100 digits/100ms

Panel Installation

TTM-J4

TTM-J5

For this panel installation, please be careful sufficiently to avoid any of damage.

Advanced Features

Self-Tuning PID (Standard)

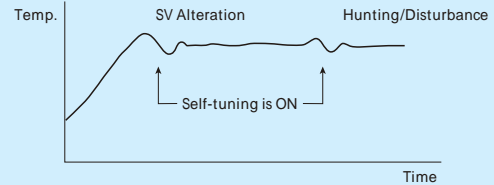

Blind Function (Standard)

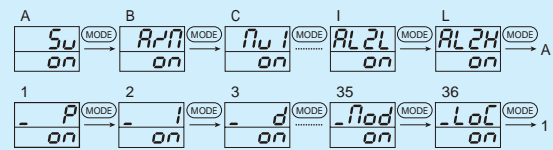

The mode screen or the parameter screen whichever you demand can be displayed by merely pressing a key, at the request.

When the SV screen is erased, the set value is normally not indicated but the measured value (PV) is only shown.

Timer Function (Standard)

1. Bread Oven Machine

Put dough into oven and press the timer start key.

While setting timer, temperature in oven is controlled by heater.

After timer counts up, control of oven is stopped automatically.

(This example is for control stop after the timer counts up.)

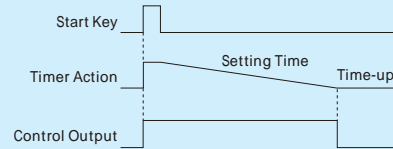

2. Package Machine and Industry Machinery

(In case of start of control after the relative equipments are prepared)

When power is "ON", the timer starts to count.

While setting timer, control output is stopped.

After the timer counts up, control is started automatically.

(For control start after the timer counts up.)

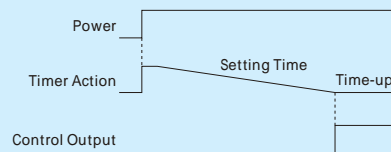

Automatic/Manual Control (Standard)

Automatic/Manual control can be switched by front key for DI or communication.

When checking the manipulation action for value and heater during a system test run, or when normal control is not operational due to sensor failure, the system can be operated manually in this mode.

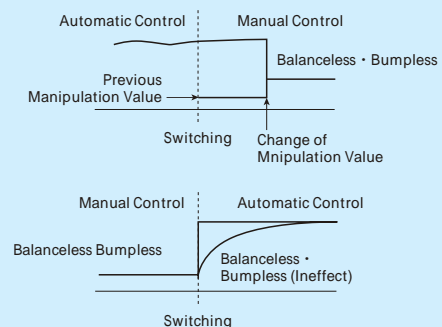

Digital PV Filter (Standard)

This is a function to realize a CR filter effect on software by means of primary delay arithmetic on the measured value (PV).

The filter effect can be set by time constant (t).
(The time constant is a period to reach 63% of PV value, when the input changes stepwise.)

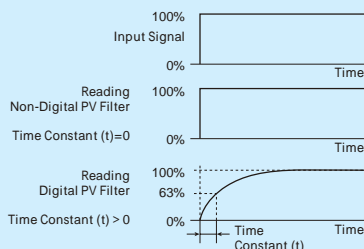

Digital PV filter with the following uses

- 1) To eliminate high frequency noise : When electric noise is added to the input, the adverse effect is reduced.
- 2) When input changes abruptly, the response delay is possibly made.

Over-Shoot Protection PID (Standard)

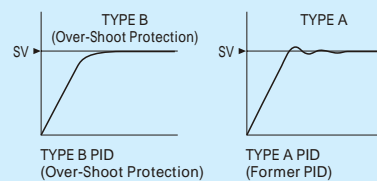

Heating/Cooling PID Control (Standard)

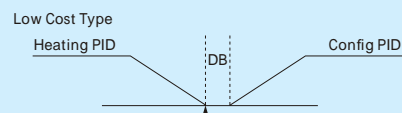

Shifting OFF Position in ON-OFF Control (Standard)

When the Shift value is set to 0 (zero), the OFF position is the set value position.

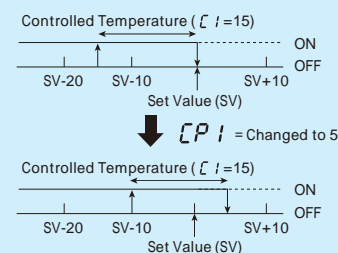

When the OFF position setting is shifted by +5, ON/OFF position shifts to that of +5 minutes upper than the original position, though the set value is not changed.
When the OFF position setting is shifted toward the minus direction, the OFF position shifts in the reverse direction.

Standard Specifications

Input Switchable	Thermocouple	K, J, T, R, N, S, B (JIS1602 ~ 1995)		
	R.T.D.	Pt100, JPt100 (Load resistance : 10 or less)		
Indication	PV (Character)	4 digits, 7 segments Green 10mm height		
	SV (Setting Value)	4 digits, 7 segments Red 8mm height		
	Various Function Indication	LED : Red (AL1, AL2, OUT1, OUT2 or RDY)		
Control Method	PID Auto-Tuning PID Self-Tuning	Proportional band (P1)	0.1 to 200.0% of setting limiter span	
		Proportional band (P2) at Output 2	0.10 to 10.00 times (Times per P)	
		Reset time (Integral) (I)	1 to 3600 sec (0 : OFF)	
		Rate time (Deviation) (D)	1 to 3600 sec (0 : OFF)	
		Cycle time (T1, T2)	1 to 120 sec	
		Dead band (DB)	-100.0 to +100.0 or -100 to +100 ()	
	ON/OFF	Control sensitivity (C1, C2)	0 to 999 or 0.0 to 999.9 ()	
	OFF Point of Output 1 & 2	Position of setting	-199 to 999 or -199.9 to 999.9 ()	
Control Output	Relay Contact	250V AC, 3A (Load resistance) 1a contact (On heating/cooling operation, output 2 is 250V AC, 2.4A load resistance, 1a contact)		
	SSR Drive Voltage	0 to 12V DC (Load resistance : Max 600 or more)		
Sampling Time	0.5 sec (Output change period is the same)			
Setting and Indication Accuracy	Thermocouple	$\pm (0.3\% + 1 \text{ digit})$ of process value or ± 2 , either of bigger numerical values is taken. (Ambient temperature : 23 ± 10) -100 to 0 : ± 3 , -200 to 100 : ± 4 Thermocouple B under 400 is not regulated.		
	R.T.D.	$\pm (0.3\% + 1 \text{ digit})$ of process value or ± 0.9 , either of bigger numerical values is taken. (Ambient temperature : 23 ± 10) Ambient temperature 0 to 50 : $\pm (0.5\% + 1 \text{ digit})$ or 1.5 , either of bigger numerical values is taken.		
Memory Element	EEPROM			
Voltage Source	100V AC to 240V AC (50/60Hz)			
Weight	TTM-J4 : less than 180g. TTM-J5 : less than 240g.			
Power Consumption	Less than 10VA (240V AC)			
Accessories	Instruction manual & installation attachment (TTM-J4) or installation metal instruments (TTM-J5)			
Operating Condition	0 to 50 , 20 to 90%RH (under non-condensation)			
Storage Condition	-25 to 70 , 5 to 95%RH (under non-condensation)			
Functions	Manipulated Variable Limiter (ML1, MH1, ML2, MH2)	0.0 to 100.0%		
	Setting Limiter (SLL, SLH)	See "Input and Range".		
	Selectable Control Mode (CNT)	Auto-Tuning PID Type A B, Normal Reverse, Auto-Tuning PID ON/OFF		
	PV Correction Setting 0 Point (PVS)	-199 to 999 or -199.9 to 999.9 ()		
	PV Correction Setting Gain	0.50 to 2.00 (times)		
	Input Filter	0 to 99 (sec)		
	Manual Reset (PBB)	0.0 to 100.0%, -100.0 to 100.0 (heating & cooling) of proportional band.		
	Timer Operation Mode (TMM)	0.00 minute to 59.59 minutes, 0.00 hour to 99.59 hours: Accuracy : $\pm (1.5\% + 0.5 \text{ sec})$ of setting time.		
	Decimal Point Shift (DP)	Decimal point display available (up to 999.9)		
	Manual Control	Auto/Manual control can be switched by key.		
	Run/Ready	Run and Ready can be switched by key.		
	Blind Function	No indication available for non-required display.		
	Auto-Tuning (AT) Coefficient	After AT, the computed PV band is newly to set up with another coefficient.		
	FUNC Key	"Digit Shift" "AT" "RUN/READY" "Timer Start/Reset"		
	Priority Display	Arbitrary paramater screens are shifted to indication of operation mode by key. (max : 9 screens)		
	Lock Function (LOC)	4 modes (OFF, ALL, Operation Lock, Lock except Operation Mode)		
	Watch Dog Function	Data checked by EEPROM (Err0), A/D converter check (Err1), and Auto-Tuning check (Err2), Built-in watch dog timer.		
	Event Output 1 (AL1) Event Output 2 (AL2 or OUT2)	Function : PV contact output (8modes), Special contact output (3 modes), additional functions (3 modes) Setting Range : -199.9 to 999.9 or -1999 to 9999 () Sensitivity : 0.0 to 999.9 or 0 to 9999 () Rating : 250V AC 2.4A (Load resistance) 1a contact When selecting output 2 at contact output 2, the output generates on cooling side during heating/cooling. Contact polarity is selectable, either normal open or normal close.		
	Heating & Cooling	See "Control Output" in standard specifications.		

Operation Flow

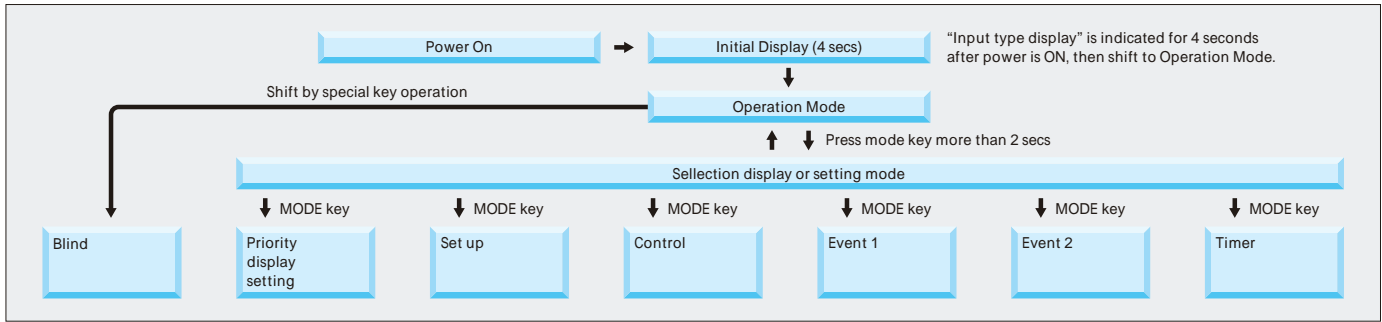

Input and Range (Thermocouple & R.T.D. switchable by key)

Thermocouple	Setting Range		Display Range	
	Non-decimal point	Decimal point	Non-decimal point	Decimal point
K	-200 ~ 1372	-199.9 ~ 990.0	-210 ~ 1382	-199.9 ~ 999.9
J	-200 ~ 850	-199.9 ~ 850.0	-210 ~ 860	-199.9 ~ 860.0
R	0 ~ 1700		-10 ~ 1710	
T	-200 ~ 400	-199.9 ~ 400.0	-210 ~ 410	-199.9 ~ 410.0
N	-200 ~ 1300	-199.9 ~ 990.0	-210 ~ 1310	-199.9 ~ 999.9
S	0 ~ 1700		-10 ~ 1710	
B	0 ~ 1800		-20 ~ 1820	

R.T.D.	Setting Range		Display Range	
	Non-decimal point	Decimal point	Non-decimal point	Decimal point
Pt100 (JIS/IEC)	-199 ~ 500	-199.9 ~ 500.0	-199 ~ 520	-199.9 ~ 530.0
JPt100 (JIS)	-199 ~ 500	-199.9 ~ 500.0	-199 ~ 530	-199.9 ~ 520.0

Timer Operation Mode

Start Mode

1	Auto start : ON delay
2	Manual start : ON delay
3	Event start : ON delay
4	Auto start : OFF delay
5	Manual start : OFF delay
6	Event start : OFF delay
7	SV start : OFF delay

ON delay : Control start or event output is ON, after time-up

OFF delay : Control stop or event output is OFF, after time-up

* Output is selectable, either main control output or event output.

Timer Drive Setting

0	Non-use timer function
1	Control output
2	Event 1 output

Wiring

TTM-J4

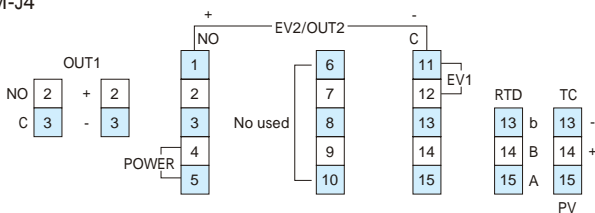

TTM-J5

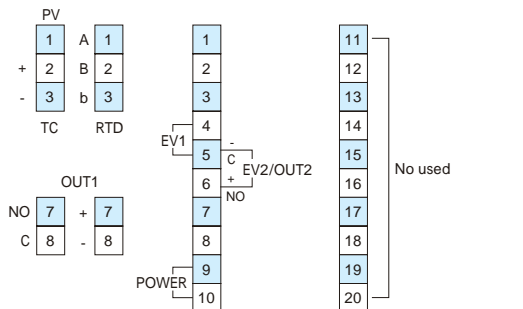

Event Contact Output Mode (Alarm)

Abnormal PV code

0	None
1	Abnormal PV contact output

Additional Functions

0	None
1	Holding
2	Awaiting sequence
3	Holding + awaiting sequence

When special function is 0, only code 0 or 1 selectable.

PV Event Code (Alarm)

0	None
1	Deviation high and low limit
2	Deviation high limit
3	Deviation low limit
4	Deviation high and low range
5	Abbsolute value high and low limit
6	Abbsolute value high limit
7	Abbsolute value low limit
8	Abbsolute value high and low range

Ordering Information

Model Output 1
TTM **AB**

Model	J4	48 x 48mm
	J5	96 x 48mm
Output 1	R	Relay contact
	P	SSR drive voltage 12V DC

- Input is selectable either thermocouple (K, J, R, T, N, S, B) or R.T.D. (Pt100, JPt100), with front key.
- "A (EV1 : Alarm 1)" and "B (EV2 : Alarm 2 or OUT2 : Relay contact)" equipped as standard specifications.

Terminals

Relay Output	C : Common. NO : Normal open
SSR Drive Output	Connect directly to + & - input of SSR
EV 1, 2	Changeable normal open & normal close
R.T.D. Input	Connect to A, B and b
Thermocouple Input	Connect to parity (+, -)

Dimensions

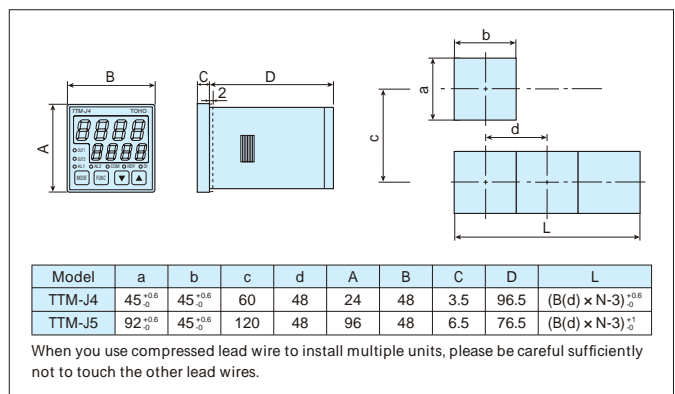

TOHO ELECTRONICS INC.

Head Office: 1-13-21, Tanashioda, Sagami-hara Kanagawa 229-1125 Japan.

Phone: +81-42-777-3311 FAX: +81-42-777-3751

E-Mail: overseas@toho-inc.co.jp

Web site: <http://www.toho-inc.co.jp>

Specifications are subject to change without notice.

Note: The color printed in this catalog may be different from actual color.