





Small Size Electromagnetic Flowsensor Model VN Series Handling Manual



 **Aichi tokei denki co., ltd.**

 Danger	Failure to follow instructions may lead to death or serious injury.
 Warning	Failure to follow instructions may lead to injury.
 Caution	Failure to follow instructions may lead to product damage (Product malfunctions, etc.).

Precautions in use

 Danger	<ol style="list-style-type: none"> 1. Do not use the VN Series for applications that requires safety, such as any nuclear, railroad, aircraft, vehicle, playground equipment, etc. 2. Do not modify the VN Series. 3. The VN Series is not designed to sanitary specifications. Do not use the product for drinks, foods, or medical liquids, etc. 4. The VN Series is not designed to explosion-proof specifications. Do not use the product in an environment with flammable gas or something similar. 5. Do not use the VN Series for corrosive liquids.
--	--



Operating environments • Liquid to be measured

 Caution	<ol style="list-style-type: none"> 1. The measurable liquid is uniform water with electric conductivity not less than 50 $\mu\text{S}/\text{cm}$. Ensure to follow this electric conductivity. In particular, note that the product cannot be used for a liquid with low conductivity such as pure water, oil, etc. 2. Ensure not to install the VN Series at places where liquid to be measured may freeze or, to the contrary, liquid temperature may exceed 60°C 3. Trying to measure liquid in which electric current is flowing may lead to abnormality of operation/function. 4. Use the VN Series within the pressure range (Not more than 1MPa). 5. The VN Series is IP64 equivalent and is not 100% waterproof structure. Do not install the product in locations where it may become submerged. 6. Do not bring a strong magnet or magnetic field close to the VN Series
---	--

Caution in application

 Caution	<ol style="list-style-type: none"> 1. 20 seconds after supplying power to the VN Series is its start-up time. Do not use outputs from and the display of the flowsensor during this period.
---	--

Piping

 <p>Caution</p>	<ol style="list-style-type: none"> 1. Do not use the VN Series at the place air bubbles enter or for measurement of the liquid containing air bubbles. And, do not install the flowsensor in the locations where air collects easily (Upstream side of a downward elbow, etc.). After installation of the flowsensor, make sure to perform sufficient air elimination before its operation. 2. Although installation position of the VN Series is free, to avoid influence of air bubbles, dart, etc., we recommend the direction of installation that LED seal-face is parallel to the ground or flow direction is vertically upward. 3. In case a flow-regulating valve, etc., that causes turbulence of flow is to be installed, its location must be at the downstream side of the flowsensor. 4. Do not install the VN Series in the piping system to which impact pressure, such as water hummer, is applied. 5. In case of new piping, install the VN Series after sufficient cleaning. 6. Arrange piping so that the flow direction conforms to the direction of the arrow indicated on the flowsensor body. 7. Do not install the VN Series in locations where strong compressive force, tensile force, or load is applied after its installation. 8. Make sure that sealing tape or adhesive agent does not protrude from the threaded portion of piping. 9. For the upstream and downstream pipes just before the VN Series to which the flowsensor is to be connected, ensure there is no fins, etc., of thread machining exists at the edges and end-faces of the pipes. 10. Do not drop the VN Series, bang it against something, or apply excessive force. Handle the product by holding its body, not to hold its cable.
 <p>Warning</p>	<ol style="list-style-type: none"> 1. Regarding the tightening torque to piping, refer to the value given below for the each the model, and do not apply higher torque to the flowsensor than specified. The flowsensor's connection thread portion(s) may be damaged and the liquid inside the piping may leak consequently. Also, 2-3 times of wrapping with sealing tape is indispensable. VN05: $3.0 \pm 0.5\text{Nm}$ VN10: $5.0 \pm 0.5\text{Nm}$ VN20: $12 \pm 1\text{Nm}$ If leakage occurs although piping is done with the torque shown above, do not perform additional tightening. Instead, check for flaws in the threaded portion or sealing tape. 2. Do not install the VN Series in locations used as footholds.

Wiring

 Danger	<ol style="list-style-type: none"> 1. Operating supply voltage of the VN Series is DC12~24V. Connecting AC100V may cause fire. 2. At the time of wiring, ensure to follow instructions of this handling manual to perform wiring. 3. Use the VN Series within the rated voltage range. Do not use the product by applying excessive load that is over the allowable load.
--	--

 Caution	<ol style="list-style-type: none"> 1. Do not place the VN Series' cable together with or near to power supply lines or power lines, etc. 2. Isolate the VN Series' cable as far as possible from any source of noise. 3. Electrical isolation of the power supply, a remote counter (a receiver), etc., from others is recommended. 4. Do not apply excessive tensile force to the cable. 5. Ensure that the cable tip is not soaked in water during wiring work.
---	--

Confirmation of the specifications

- Please confirm the descriptions on the upside of the packing box and on the backside of the flowsensor conform to the ordered specifications.
- As there are 2 channels of outputs, please also confirm the specification of the each of 1CH and 2CH is correct.

Wiring

- The wiring method is as the following diagram.

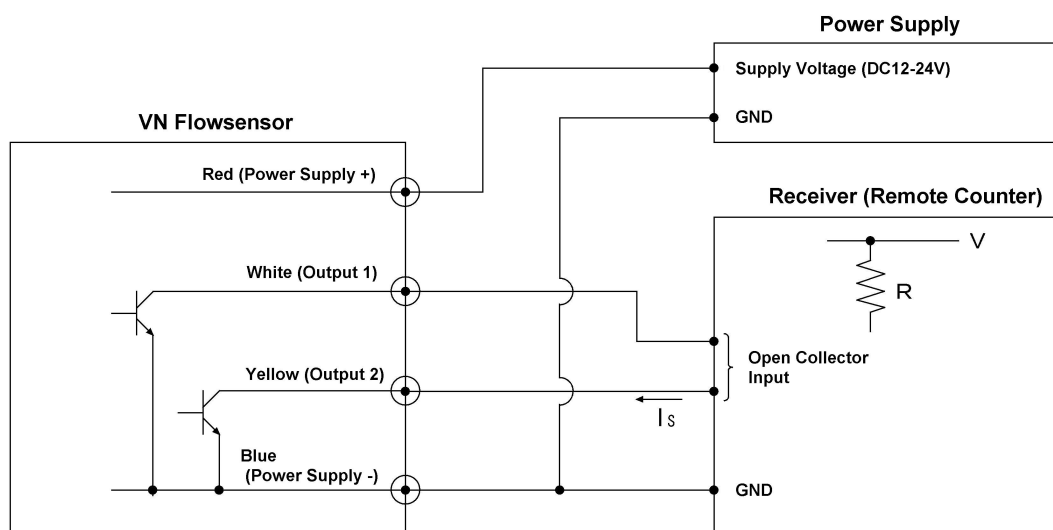

$$I_s \text{ (Absorbing current of output)} = \frac{V \text{ (Pull-up voltage)}}{R \text{ (Pull-up resistance)}} \leq 20\text{mA}$$

Pull-up voltage shall be not more than 30V, and I_s (Absorbing current of output) shall be not more than 20mA for the each.

LED display

- With 2-colors LED of green and red, either of flow-rate status or alarm information is displayed. Alarm information by error detection has priority of indication. And, only the information that has the highest priority is displayed.

Green: Status of flow-rate is indicated with 4 patterns, which are combination of 3 steps for flashing and lighting.

Red: Content of alarm (error detection) is indicated with 6 patterns that are combinations of 4 steps for flashing, lighting, and No-light.

1. Flow information (Green)

- Flow-rate ranges and patterns of indications

Flow-rate range	Patterns of indication
Less than zero-cut flow-rate	Continuous LIGHTING
Zero-cut flow-rate ~ 1/3 of the upper limit of the accuracy guaranteed flow-rate range	Flashing of 2 seconds cycle. Repeating of 1 second LIGHTING and 1 second of NO-LIGHT.
1/3 ~ 2/3 of the upper limit of the accuracy guaranteed flow-rate range	Flashing of 1 seconds cycle. Repeating of 0.5 second LIGHTING and 0.5 second of NO-LIGHT.
More than 2/3 of the upper limit of the accuracy guaranteed flow-rate range	Flashing of 0.4 seconds cycle. Repeating of 0.2 second LIGHTING and 0.2 second of NO-LIGHT.

(Zero-cut flow-rate - 2/3 of the upper limit of the accuracy guaranteed flow-rate range)

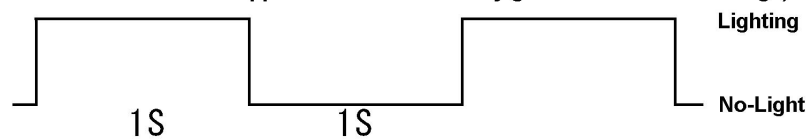

(1/3 - 2/3 of the upper limit of the accuracy guaranteed flow-rate range)

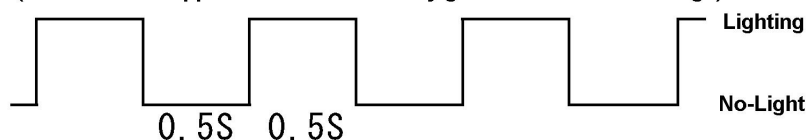

(More than 2/3 of the upper limit of the accuracy guaranteed flow-rate range)

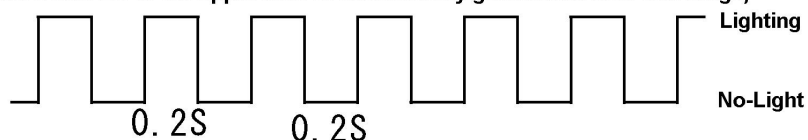

2. Alarm information (Red)

- Details of the alarm items

Name of alarm	Content
Excitation error detection	Electric current does not correctly flow through the excitation coil.
Memory error detection	Error of data at the memory is detected.
Low power voltage detection	Power voltage lower than 9.6V is detected.
No-water detection	The measuring pipe is not fulfilled with liquid to be measured (Partially filled condition).
Excessive liquid noise detection	Condition that correct measuring is obstructed because abnormal current is flown on the liquid to be measured, the liquid contains air bubbles, etc.
Reverse-flow detection	Reverse flow (flow direction opposite to the arrow shown on the flowsensor's body), which flow-rate is more than the zero-cut flow-rate point, is detected.
Excessive flow-rate detection	Not less than 25% excess from the upper limit of the accuracy guaranteed flow-rate range is detected.

- Error detection items and patterns of indications

Error detection item	Priority	Patterns of indication
Low power voltage detection	1	No-LIGHTING of the both green and red
Excitation error detection or Memory error detection	2	Continuous LIGHTING
No-water detection	3	Repeating of 1 time of 0.3 second LIGHTING and 2 second of NO-LIGHT
Excessive liquid noise detection	4	Repeating of 3 times of 0.3 second LIGHTING and 0.3 second of NO-LIGHT + 1.7 second of NO-LIGHT
Reverse-flow detection	5	Repeating of 2 times of 0.3 second LIGHTING and 0.3 second of NO-LIGHT
Excessive flow-rate detection	6	Repeating of 4 times of 0.3 second LIGHTING and 0.3 second of NO-LIGHT

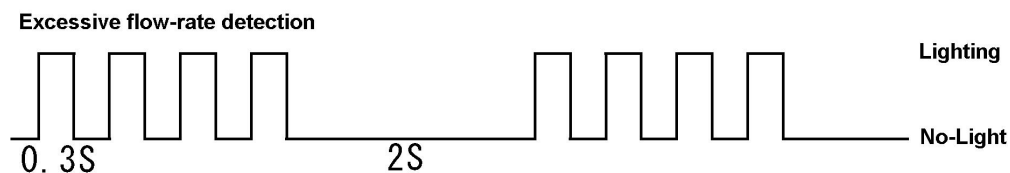
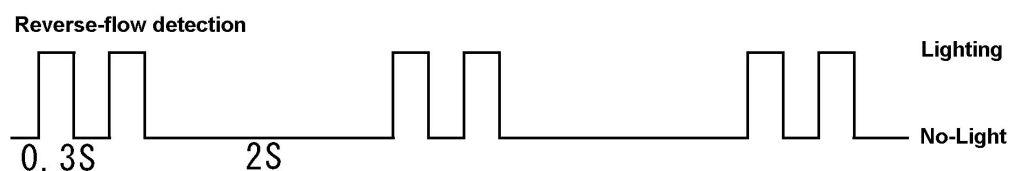
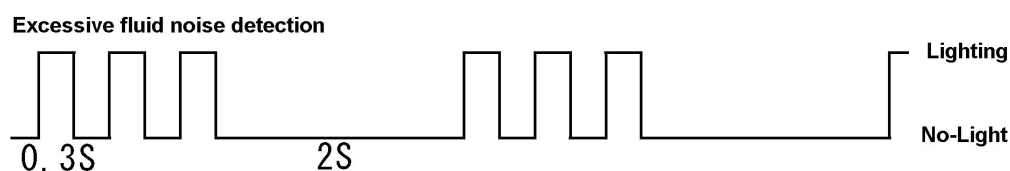
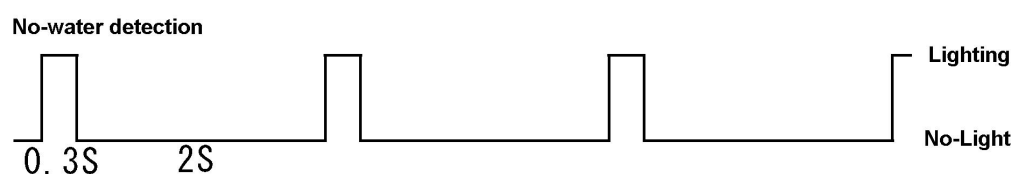

Warranty period

Period of warranty for the product is within 1 year from the date of shipment.

Our measuring instruments, etc. are of ISO9001 acquisition.

